







RM60

-  Kg/batch: flexible 15 - 60
-  Roasting time: flexible 8 - 20 minutes
-  Output: up to 240 kg/h
-  Roasting profile control
-  Double function heating chamber
-  Full automatic process
-  Compact design



IMF industrial roasters are ideal for high volume production, with a focus on process optimisation, costs and harmful emissions reduction, energy savings.

All IMF models are equipped with a particular re-circulation of hot air system through a single heating chamber with double function, allowing the energy necessary for the roasting process, reducing emissions concentration at the same time.

VORTEX

Thanks to the patented VORTEX system, the generated hot air is mixed with fresh air to reach accurate temperature control in

the roasting drum for a **perfect and consistent roasting process**.

The internal air partition conveyance system allows the heat to be equally distributed internally and externally of the roasting chamber, ensuring a uniform heat transfer to each single coffee bean, for gentle and perfect roast.

The integrate software of roasting process developed from IMF allow to preset and control roasting parameters such as air-flow and rotational drum speed, in order to achieve a highly **accurate repeatability** of batches.

ADVANTAGE FEATURES

QUALITY AND EFFICIENCY

- Convection roasting method - indirect hot air heating
- Designed drum for accurate air/beans blending ratio
- Single burner for roasting and emission treatment
- Significant reduction gas consumption
- Heat recycle system for high performance energy saving
- Internal insulated pipes for safety and heat retention
- Low emission levels
- Chaff collecting cyclone with automatic extraction
- Stainless steel cooling tray
- Compact lay-out, reduced foot print
- Dark roasting profile available

CONTROL MANAGEMENT AND SAFETY

- Insulated hot air pipes
- Water quenching in the roasting drum available
- Roasting profile management software
- Vortex patented valve for accurate air temperature control
- Control system for roasting air flow and drum speed regulation
- Modulating heat power
- Rate of rise (RoR) control
- Accurate batch repeatability
- HMI touch panel
- PLC
- Compatibility with external roasting software
- Ethernet port for PC connection
- Router for remote assistance service

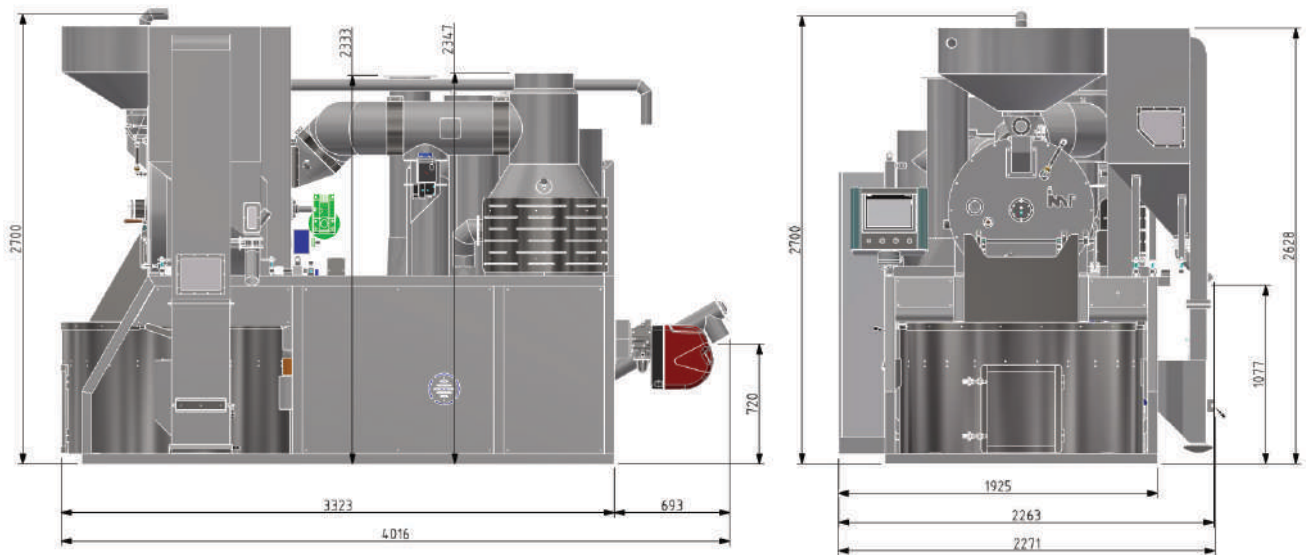

I.M.F. S.r.l - INDUSTRIA MACCHINE FERRARESE
Via delle Scienze, 6 - 45030 Occhiobello (RO) - Italy - Tel. +39 0425 760109
info@imf-srl.com - www.imf-srl.com

